

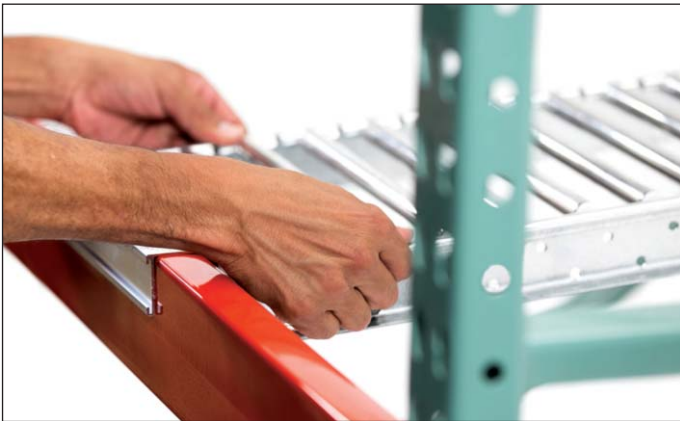

span//track

THE  
ORIGINAL  
CARTON FLOW  
TRACK

Engineered Space Optimization



SpanTrack is UNEX's innovative carton flow solution that drops into existing structures to create a robust flow system for any operation. Our full-width roller lanes and universal wheel beds are engineered-to-order to create the ultimate order picking environment.

### Benefits

#### Versatility

SpanTrack can be added to any new or existing pallet rack. No shelves or intermediate support required.

#### Superior Flexibility

SpanTrack provides the flexibility to store products with a wide variation in size and weight.

#### High Capacity, Durability

SpanTrack takes the abuse of active warehouses and assembly plants.

#### Unrivaled Flow

SpanTrack provides maximum carton support and up to 300% more product contact than plastic wheel rails, resulting in better flow, fewer hang-ups and increased throughput.

## Typical Configurations

### Full Case Picking

Low Profile SpanTrack drops into existing pallet rack, creating FIFO storage lanes that are ideal for full case picking.



### Split Case Picking

SpanTrack with adjustable pick trays presents open cases to order pickers so product can be picked from the case without interference from the shelf level above.





**SpanTrack Lane and Bed Shared Features**

- Drop-in design for easy installation
- Freezer/cooler rated to below zero
- Light, standard, and heavy duty capacity choices
- Knuckled end treatment for improved ergonomic each picks
- Customizable end treatments that attach easily to any pallet rack setup
- Interior notching saves vertical space
- Available in to-the-inch increments
- 7-year warranty



**SpanTrack Lane Features**

- Provides 300% more product contact than plastic wheel
- Integrated label holder system
- Optimized for product stacking
- The original carton flow track

**SpanTrack Bed Features**

- Maximum flexibility left-to-right for reslotting
- Shark fin infeed guides ease replenishment
- Hex hub wheel design for optimal flow
- The latest innovation from UNEX



**Low Profile (S2)**  
Nests between beams on hangers for maximum use of vertical space. Used for full case or each pick. Perfect for racks with pallet storage above.



**Hangerless (S9)**  
Adjustable length track sits on the ledge of step beams in the front and rear, keeping the face of the beams clear.



**Low Profile Knuckle (KLx)**  
12", 16", 20" and 24" long  
20° angled front end for increased efficiency in each pick applications within the rack structure.



**Pushback (S4)**  
Notched track sits on top of step beams, with stops on front and rear, making it ideal for applications where product is loaded and picked from the front.



**High Profile (S0)**  
Rests on rack beams. Easily adjusts for various contouring options. Can overhang structure to increase storage capacity.



**High Profile Knuckle (Kx)**  
Rests on rack beams. Overhangs structure up to 24" with 20° angled front end for increased efficiency in each pick applications.

## Each Pick Options

### ADD-ON PICK TRAY: 12", 15" DEPTH / 2" LIP / UP TO 96" WIDE

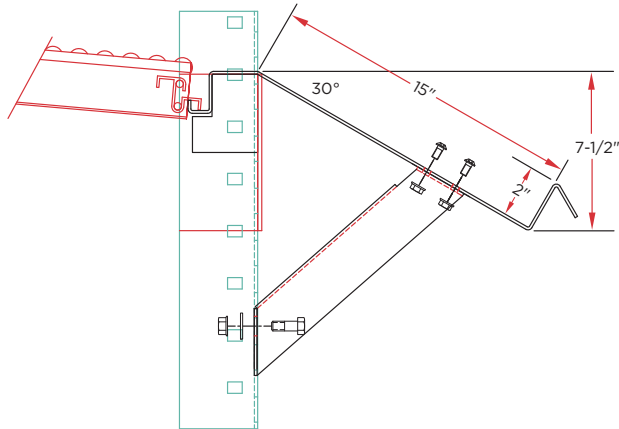

### ADJUSTABLE PICK TRAY: 18", 24" DEPTH / 2" OR 4" LIP

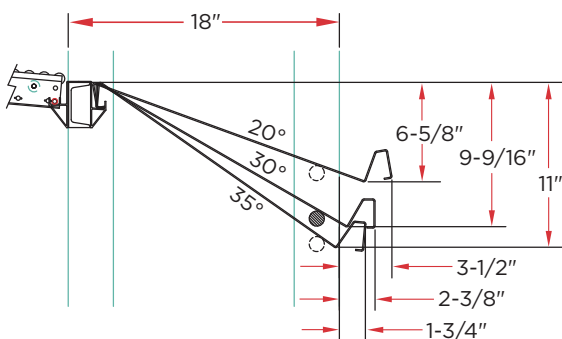

**Part Number Example - SpanTrack**

<b>98</b>	<b>S2</b>	<b>R or W</b>	<b>6</b>	<b>2</b>	<b>x79</b>
SERIES	END STYLE	ROLLER TYPE	TRACK WIDTH	ROLLER CENTERS	LENGTH

## Selecting the Correct Track Width

### SpanTrack Lane Width Guide

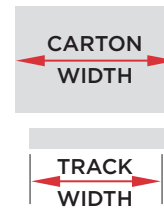

**SpanTrack Lane** is available in 6 different widths at varying capacities. Product width will be the primary factor in determining lane width. Product can overhang the lane, up to 3" on either side and maintain flow.

SpanTrack Width	Maximum Carton Width
6"	8"
9"	13-1/2"
12"	18"
15"	22-1/2"
18"	25-1/2"
24"	31-1/2"

### SpanTrack Bed Width Guide



**SpanTrack Bed Widths** are determined by the best track combination that fits within the width of the racking. Example: for a 96" wide bay, you can use (4) 18" wide beds & (2) 12" wide beds. This will create a 96" wide level of carton flow.

SpanTrack Bed Width	OAW	Series
12"	11.7"	98, 99
18"	17.7"	98, 99
12"	11.75"	100
15"	14.75"	100
18"	17.75"	100
24"	23.75"	100

### 98/99 Series Roller Center Guide

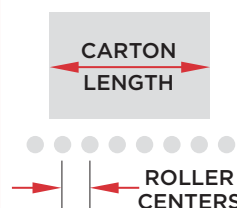

**Roller Centers** refers to the spacing between rollers within the sections. As product increases in length, additional space can be added between rollers/wheels. Having closer roller centers will increase the conveying surface and make the system more flexible.

Minimum Carton Length	Maximum Roller Center
4"	1"*
8"	2"
12"	3"

\* Lane only



**0.75" Roller** is available in aluminum (R) and **steel (SR)**.  
**98 & 99 series**



**1.38" Roller (JRS)** is made of galvanized steel with bearings.  
**100 series**

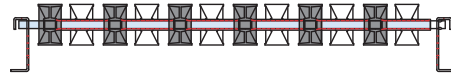
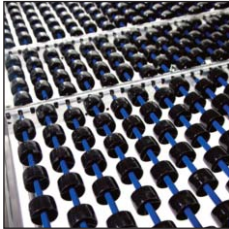

**1.6" Hex Hub (W)** Patent pending low friction wheel bed design  
**98 & 99 series**

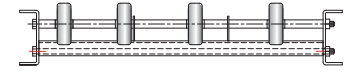
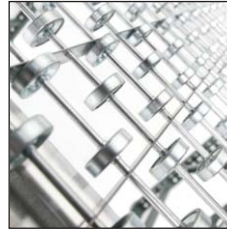

**1.9" Skatewheel (SW)** is available in steel and each wheel has a bearing.  
**100 series**

### SpanTrack Capacities

UNSUPPORTED SPAN (in)	LIGHT DUTY	STANDARD DUTY	HEAVY DUTY		
	98 Series (2-5/32") 6", 9", 12", 15", 18"* Roller - Lane (lbs/linear ft) Wheel - Bed (lbs/sq ft)	99 Series (2-1/2") 6", 9", 12", 15", 18"* Roller - Lane (lbs/linear ft) Wheel - Bed (lbs/sq ft)	100 Series (2-1/2") 9", 12", 15", 18", 24" Roller - Lane (lbs/linear ft)	100 Series (2-1/2") 12", 15", 18" Wheel - Bed (lbs/sq ft)	100 Series (2-1/2") 24" Wheel - Bed (lbs/sq ft)
36	35	50	100	100	100
48	35	50	100	100	100
60	35	50	100	100	100
72	35	50	100	100	85
84	35	50	100	100	75
90	35	45	100	100	65
96	30	40	100	80	55
102	25	35	90	70	45
108	20	30	75	55	40
114	15	25	65	50	35
120	10	20	55	40	30
126			50	40	25
132			40	30	20
138			35	25	20
144			30	25	15

\*Bed only

#### 98 SERIES - LD

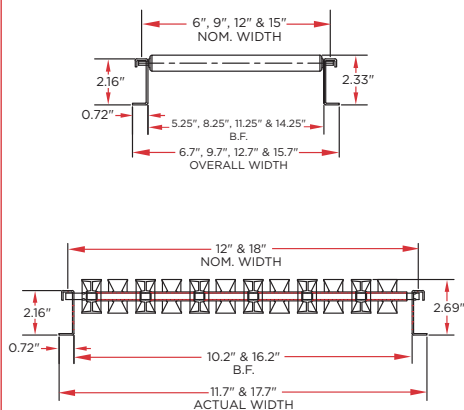

#### 99 SERIES - SD

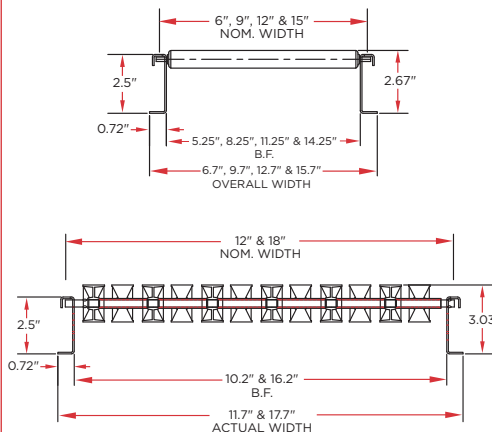

#### 100 SERIES - HD

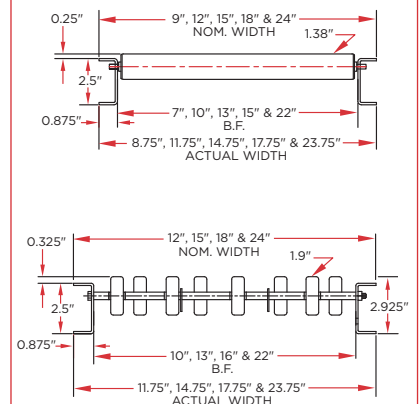



### Impact Plate

Steel impact plates snap onto rollers to provide a steel surface for impact loading



### Impact Zone

Impact zones have added rollers or wheels to the first 12" or 18" of the load end of the track

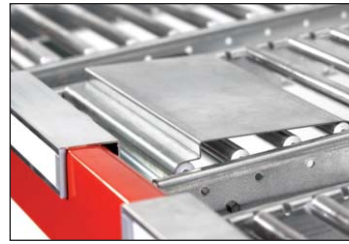

### Raised Pressure Relief Ramp Stop

Relieves line pressure on the first case, creating an easier pick



### Slow Down Strips

Narrow strips snap onto rollers for precise flow modulation



### Infed Guides - Lane

Bolts onto the side channel, designating the location of the pick facing



### Infed Guides - Bed

"Shark fin" design snaps onto axles, guiding product replenishment



### Label Holders

Self-adhesive backed extruded plastic label holder



### Guard Rail

Full-length lane dividers that bolt onto the side channels of the tracks. 2 sizes available.



### Internal Notch

Accommodates an infinitely adjustable interior support beam to minimize clearance



### Swing Stop

Spring-loaded stop that operator lowers when accessing product



### Rigid Splice

For splicing two square end tracks



### Low Profile Bridge Splice

For splicing two notched end tracks for vertical space savings



### Keg Flow

An innovative solution for high density storage of microbrew kegs

For more information, see the [Keg Flow Literature](#).

## The SpanTrack Advantage

- Increased facings
- Full-depth storage
- Safe, ergonomic picks
- Product always up front
- Easy to restock
- FIFO stock rotation